



Livestock Tent

SSL202012H 20'x20'x12'

W6.0xL6.0xH3.7m

Assembly Instructions



RECOMMENDED TOOLS



Please read instructions **COMPLETELY** before assembly. This shelter **MUST** be securely anchored. **THIS IS A TEMPORARY STRUCTURE AND NOT RECOMMENDED AS A PERMANENT STRUCTURE.**

Before you start: 4+ individual recommended for assembly, approximate time 5 hr.

ATTENTION:

This shelter product is manufactured with quality materials. It is designed to fit our custom fabric cover included. Our shelters offer storage and protection from damage caused by sun, light rain, tree sap, animal - bird excrement and light snow. Please anchor this structure properly. See manual for more anchoring details. Proper anchoring, keeping cover tight and free of snow and debris is the responsibility of the consumer. Please read and understand the installation detail, warnings and cautions prior to beginning installation. If you have any questions contact your local dealer.

DANGER:

Prior to installation, choose the location of your shelter carefully._

DANGER: Keep away from electrical wires.

Check for overhead utility lines, tree branches or other structures. Check for underground pipes or wires before you dig. DO NOT install near roof lines or other structures that could shed snow, ice or excessive run off onto your shelter. DO NOT hang objects from the roof or support cables.

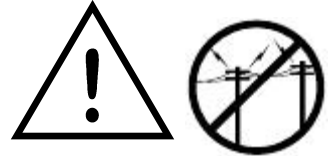

WARNING:

Risk of fire. DO NOT smoke or use open flame devices (including grills, fire pits, deep fryers, smokers or lanterns) in or around the shelter. DO NOT store flammable liquids (gasoline, kerosene, propane, etc.) in or around your shelter. Do not expose top or sides of the shelter to open fire or other flame source.



CAUTION:

Use **CAUTION** when erecting the frame. Use safety goggles during installation. Secure and bolt together overhead poles during assembly. Beware of pole ends.

PROPER ANCHORING AND INSTALLATION OF FRAME:

PROPER ANCHORING OF THE FRAME IS THE RESPONSIBILITY OF THE CONSUMER.

We are not responsible for damage to the unit or the contents from acts of nature. Any shelter that is not anchored securely has the potential to fly away causing damage, and is not covered under the warranty. Periodically check the anchors to ensure stability of shelter. We cannot be responsible for any shelter that blows away._

NOTE: Your shelter's cover can be quickly removed and stored prior to severe weather conditions. If strong winds or severe weather is forecast in your area, we recommend removal of cover.

CARE AND CLEANING:

A tight cover ensures longer life and performance. Always maintain a tight cover. Loose fabric can accelerate deterioration of cover fabric. Immediately remove any accumulated snow or ice from the roof structure with a broom, mop or other soft-sided instrument. Use extreme caution when removing snow from cover- always remove from outside the structure. DO NOT use hard-edged tools or instruments like rakes or shovels to remove snow. This could result in punctures to the cover. DO NOT use bleach or harsh abrasive products to clean the fabric cover. Cover is easily cleaned with mild soap and water.











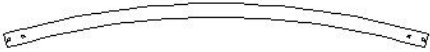

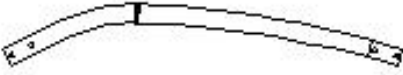
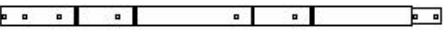
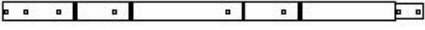

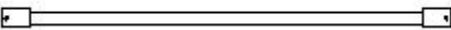
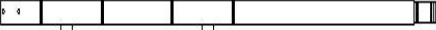



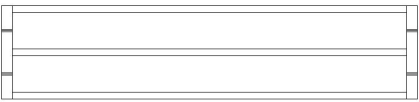
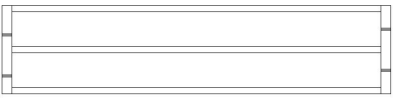



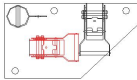
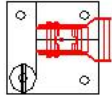

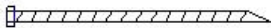

WARRANTY:

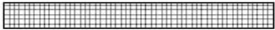
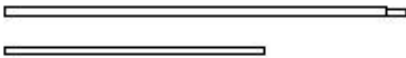
This shelter carries a full limited warranty against defects in workmanship. We warrant to the Original Purchaser that if properly used and installed, the product and all associated parts, are free from manufacturer's defects for a period of:

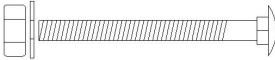
1 YEAR FOR COVER FABRIC, END PANELS AND FRAMEWORK

Livestock Tent SSL202012H (W6.0xL6.0xH3.7m) Parts List

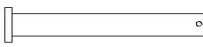
Part Code	Description	Qty/ PCS
1	Top Bent Joist 	4
2	Roof Bent Joist 	8
3	Sidewall Bent Joist 	8
4	Upright for front and back end (left) 	2
5	Upright for front and back end (right) 	2
6	Upright for middle arch 	4
7	Purlin 	21
8	Portal for front end 	2
9	Portal for back end 	2
10	Portal for front end with hole for No.11 	2
10A	Portal for back end 	2
11	Cross Beam for front end 	1
12	Fence 	12
13	Fence 	10
14	Gate (left) 	1
15	Gate (right) 	1

16	Base Plate for corners		4
17	Base Plate for middle arch		4
18	Base Plate for front and back end		4
19	Stake Peg		32
20	Roof Cover		1
21	Front Cover		1
22	Back Cover		1
23	Webbing for Winch		8
24	Tensioning Tube for roof cover (3pcs/set)		2 sets
25	Knitting Rope for roof cover		1 bundle
26	Plastic Plug for No.24		4
27	Carriage Bolt M10x80 for purlins		68
28	Bolt M8x70 for arches		80
29	Bolt M10x80 for fence		24
30	Bolt M8x50 for front end		8
31	Tube Clip		4
32	Pin for Gate (No.14, 15)		4
33	Rod for picking up front door cover zipper		1
34	Bolt M8x80		4

Frame Installation

Step 1: base plates and stake pegs

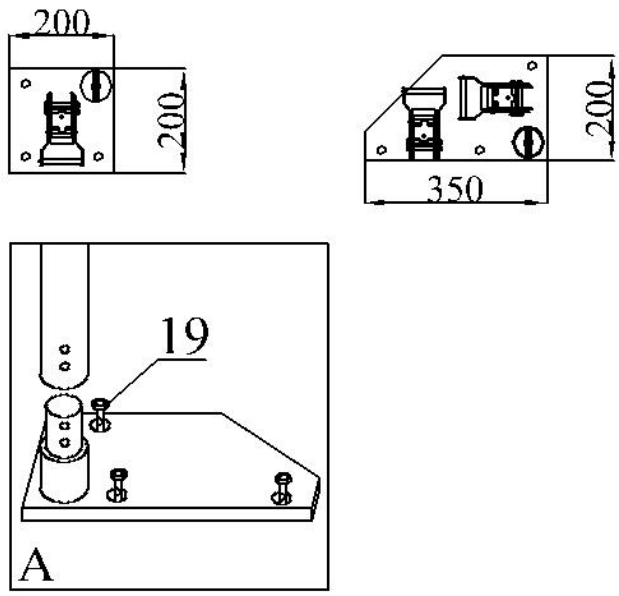
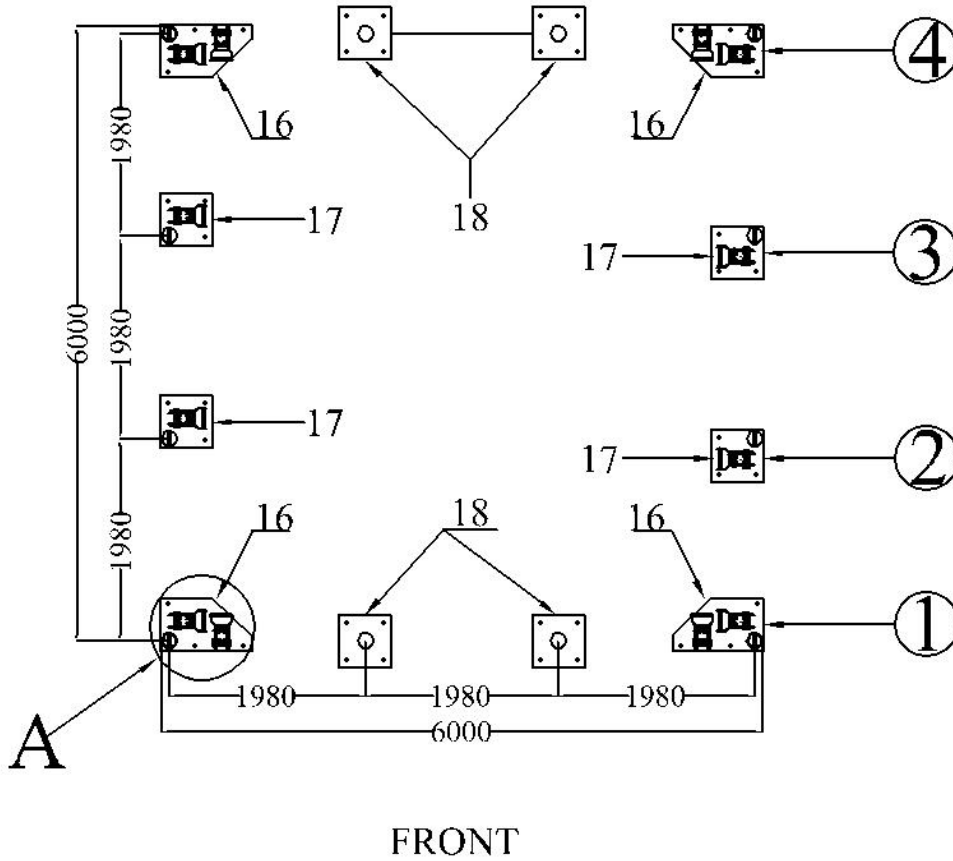

Step 2: arch No.1 and portals and fences

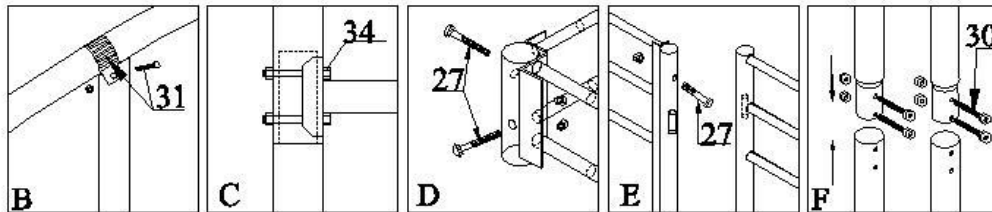
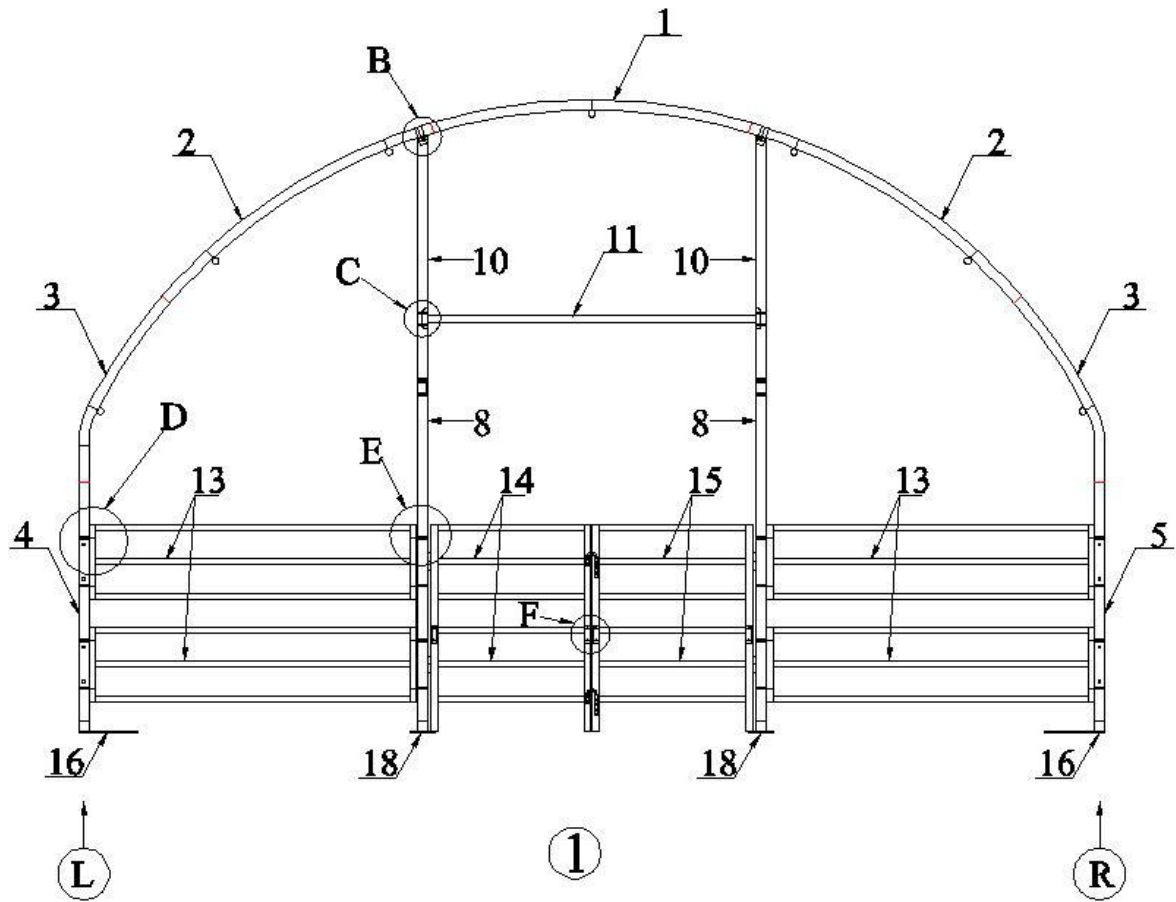

Step 3: middle arches No.2 & 3

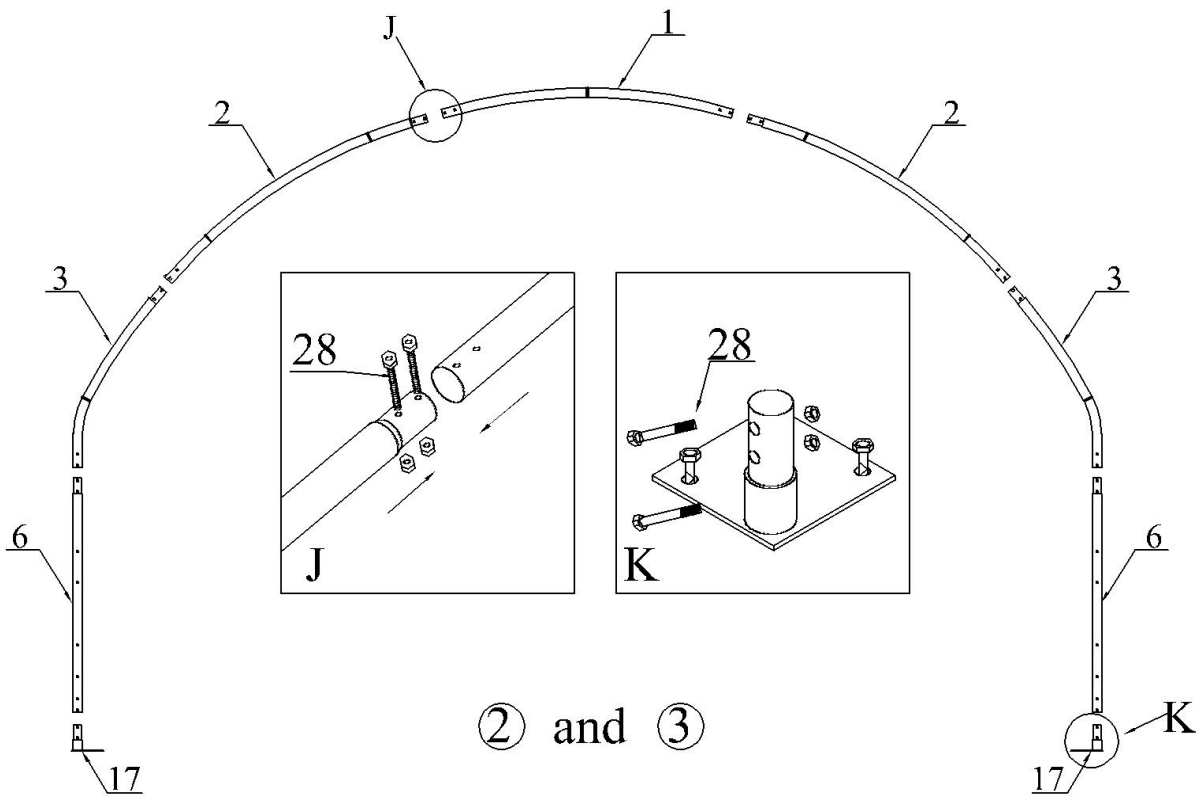

② and ③

Step 5: purlins and sidewall fences

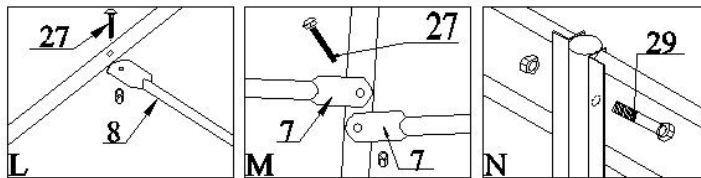
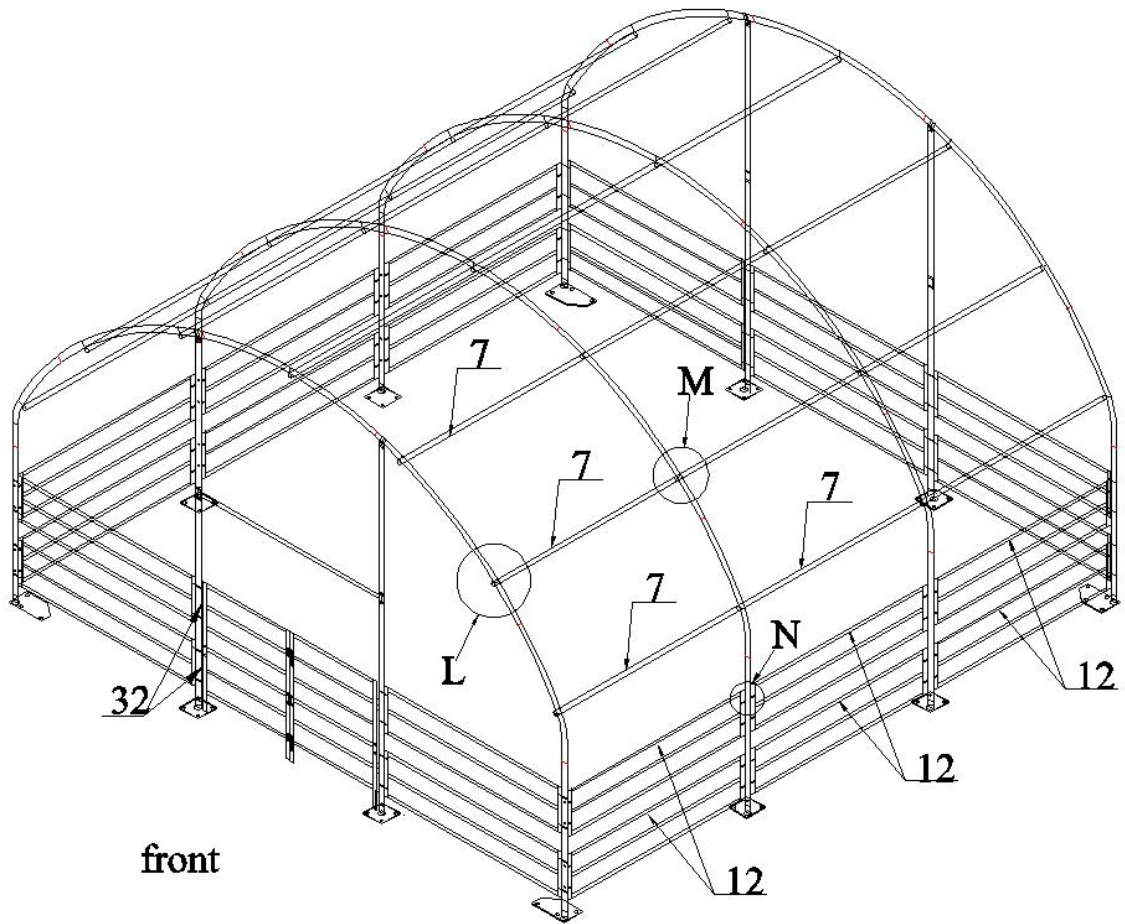

Step 6: squaring up the frame and fix base plates by stake peg

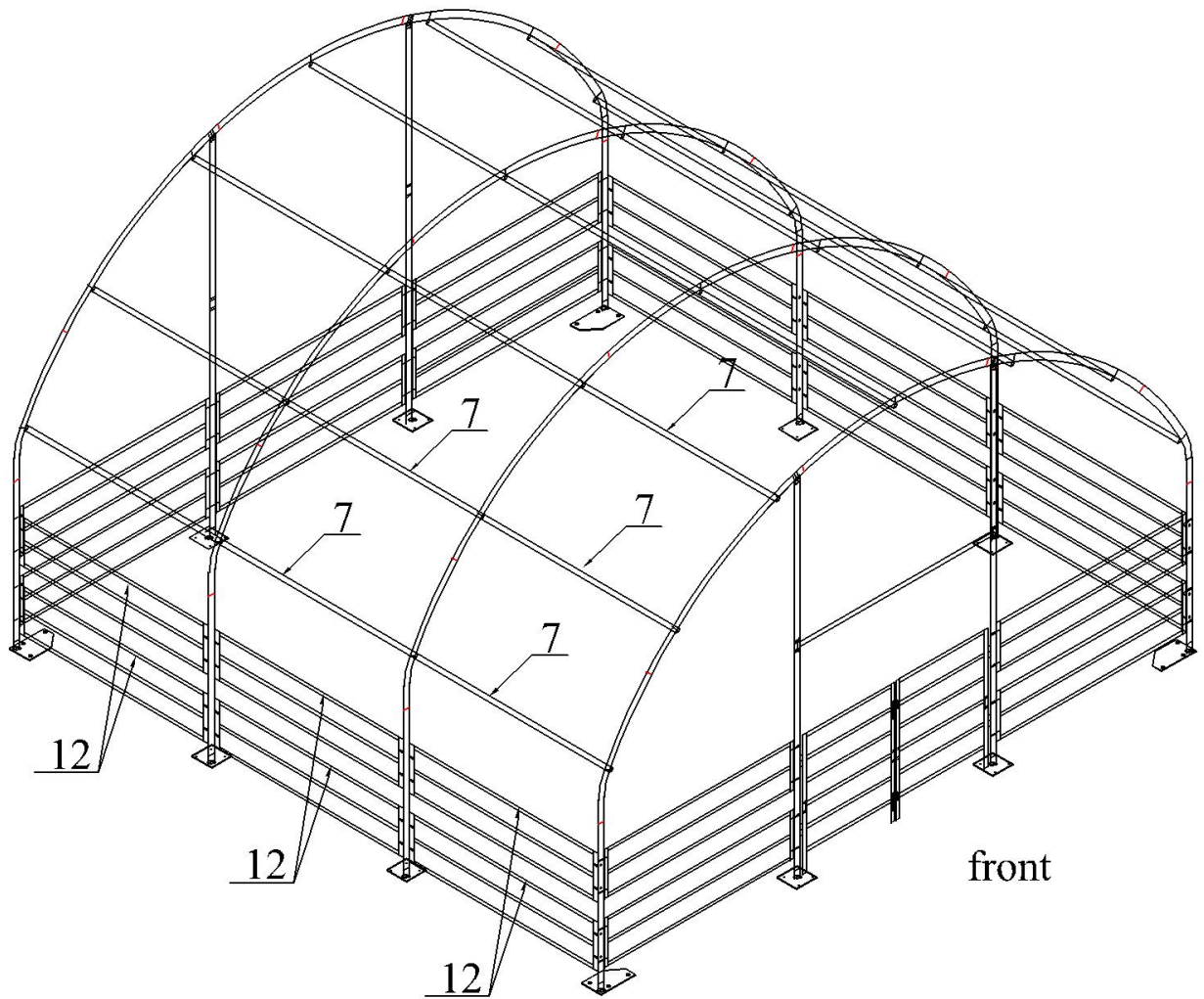

Cover Installation

Step 1: front cover with door

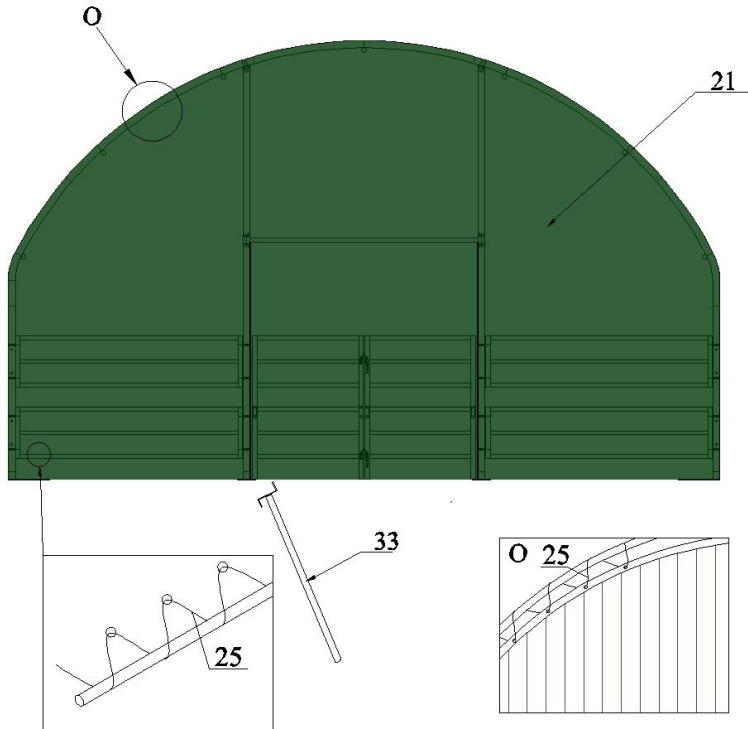

Step 2: back cover

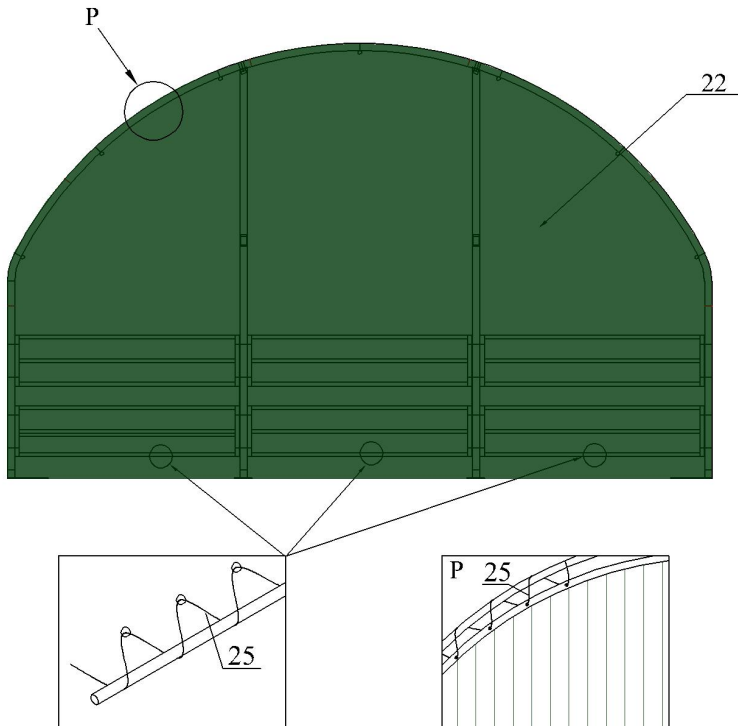

Step 3: roof cover

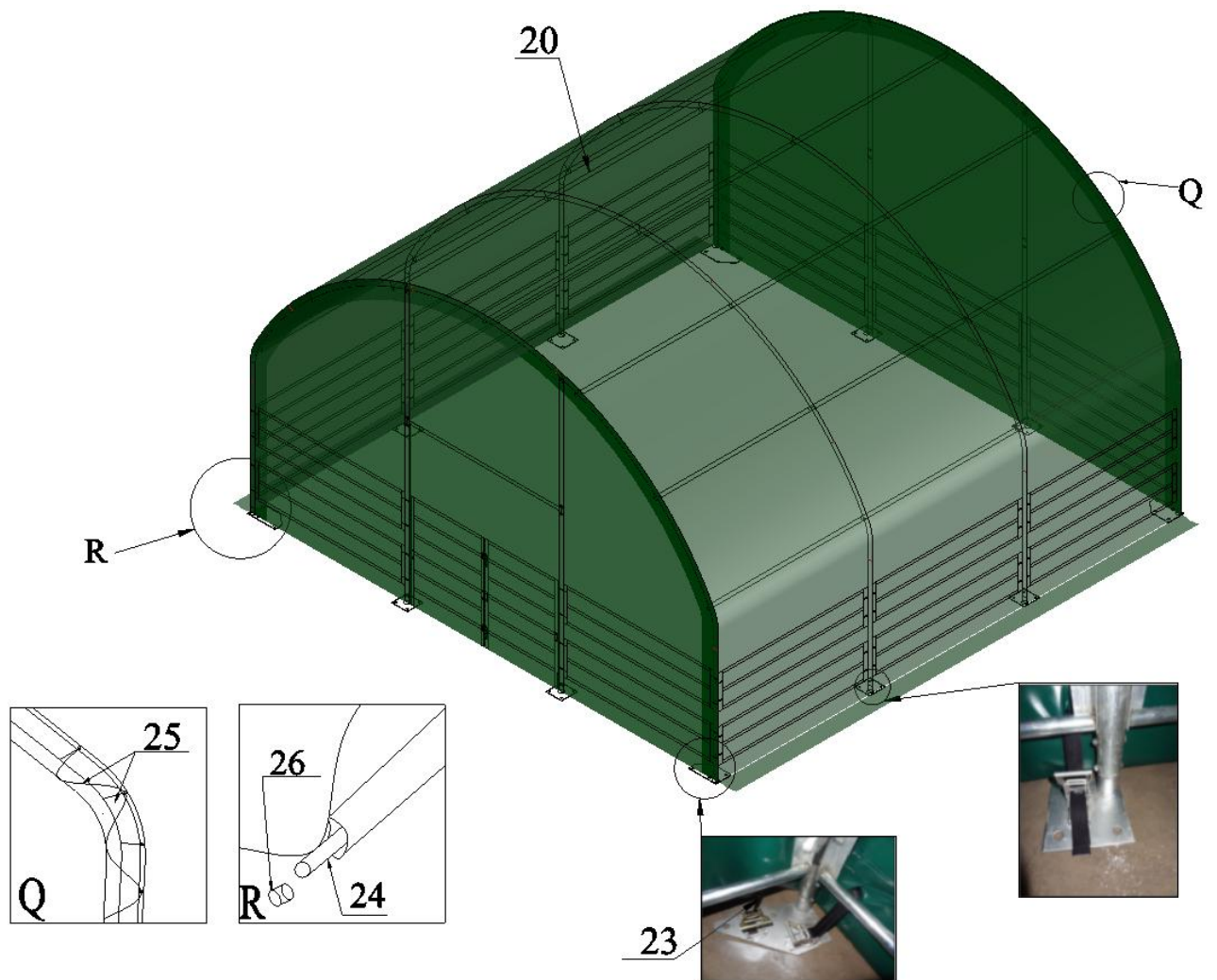

Now your assembly is completed.