

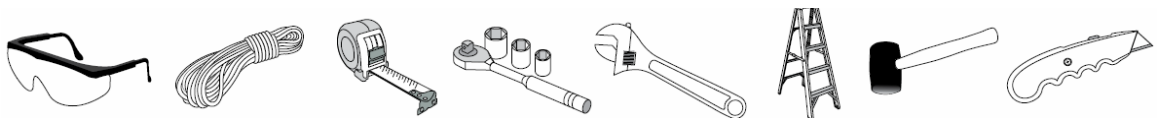

Portable Garage
122509R 12'x25'x9'
W3.66xL7.62xH2.72m
Assembly Instructions



RECOMMENDED TOOLS



Please read instructions **COMPLETELY** before assembly. This shelter **MUST** be securely anchored. **THIS IS A TEMPORARY STRUCTURE AND NOT RECOMMENDED AS A PERMANENT STRUCTURE.**

Before you start: 2+ individual recommended for assembly, approximate time 2 hr.

ATTENTION:

This shelter product is manufactured with quality materials. It is designed to fit our custom fabric cover included. Our shelters offer storage and protection from damage caused by sun, light rain, tree sap, animal - bird excrement and light snow. Please anchor this structure properly. See manual for more anchoring details. Proper anchoring, keeping cover tight and free of snow and debris is the responsibility of the consumer. Please read and understand the installation detail, warnings and cautions prior to beginning installation. If you have any questions contact your local dealer.

DANGER:

Prior to installation, choose the location of your shelter carefully. _

DANGER: Keep away from electrical wires.

Check for overhead utility lines, tree branches or other structures. Check for underground pipes or wires before you dig. DO NOT install near roof lines or other structures that could shed snow, ice or excessive run off onto your shelter. DO NOT hang objects from the roof or support cables.



WARNING:

Risk of fire. DO NOT smoke or use open flame devices (including grills, fire pits, deep fryers, smokers or lanterns) in or around the shelter. DO NOT store flammable liquids (gasoline, kerosene, propane, etc.) in or around your shelter. Do not expose top or sides of the shelter to open fire or other flame source.



CAUTION:

Use **CAUTION** when erecting the frame. Use safety goggles during installation. Secure and bolt together overhead poles during assembly. Beware of pole ends.

PROPER ANCHORING AND INSTALLATION OF FRAME:

PROPER ANCHORING OF THE FRAME IS THE RESPONSIBILITY OF THE CONSUMER.

We are not responsible for damage to the unit or the contents from acts of nature. Any shelter that is not anchored securely has the potential to fly away causing damage, and is not covered under the warranty. Periodically check the anchors to ensure stability of shelter. We cannot be responsible for any shelter that blows away. _

NOTE: Your shelter's cover can be quickly removed and stored prior to severe weather conditions. If strong winds or severe weather is forecast in your area, we recommend removal of cover.

CARE AND CLEANING:

A tight cover ensures longer life and performance. Always maintain a tight cover. Loose fabric can accelerate deterioration of cover fabric. Immediately remove any accumulated snow or ice from the roof structure with a broom, mop or other soft-sided instrument. Use extreme caution when removing snow from cover- always remove from outside the structure. DO NOT use hard-edged tools or instruments like rakes or shovels to remove snow. This could result in punctures to the cover. DO NOT use bleach or harsh abrasive products to clean the fabric cover. Cover is easily cleaned with mild soap and water.

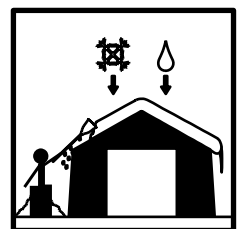









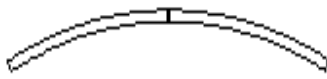

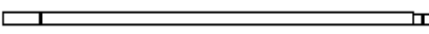
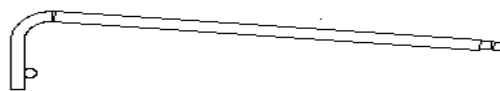

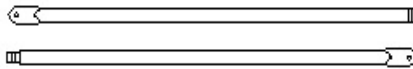
WARRANTY:

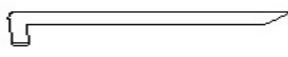
This shelter carries a full limited warranty against defects in workmanship. We warrant to the Original Purchaser that if properly used and installed, the product and all associated parts, are free from manufacturer's defects for a period of:

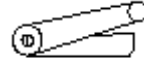
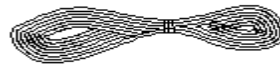
1 YEAR FOR COVER FABRIC, END PANELS AND FRAMEWORK

Portable Garage W3.66xL7.62xH2.72m Parts List

Part Code	Description of Parts	Qty(PC)	Box	
1	Roof Bent Tube		6	A
2	Sidewall Bent Tube		12	A
3	Upright for middle arches		8	A
4	Upright for front and back arches		4	A
5	Purlin		5	A
6	Purlin with one end swaged		20	A
7	Bracing Tube		2	A
8	Bolt M6x70		30	A
9	Bolt M6x35		2	A
10	Stake Peg for tube clip No.11		24	A
11	Tube Clip for purlins near the ground		12	A
12	Winch for roof cover tensioning		4	A
13	Knitting Rope		1 bundle	A
14	Cable Tie		45	A
15	Plastic Plug for purlins No.5, 6		10	A
16	Plastic Plug for upright No.4		4	A
17	Roof Cover, Front Cover & Back Cover		1	B

Arches and Purlins Installation

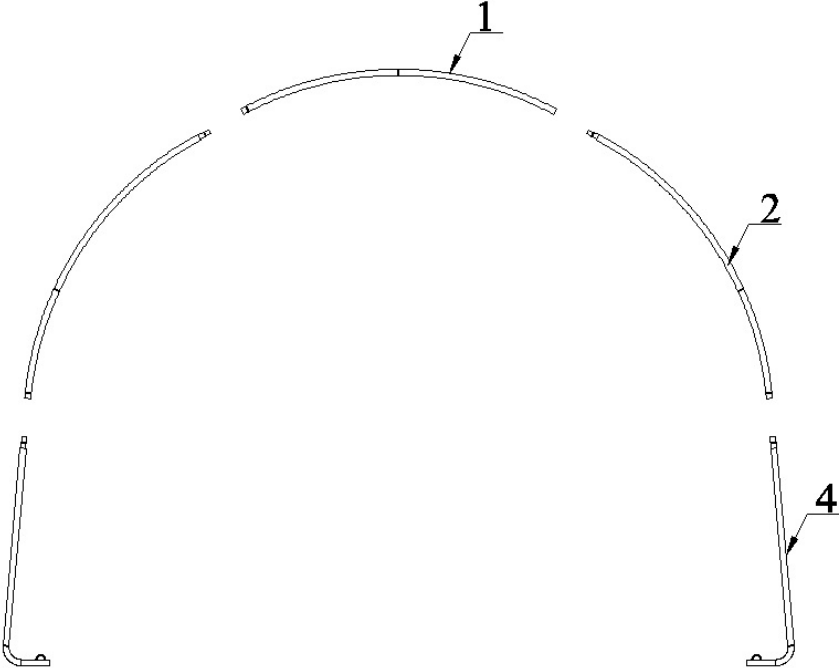

Front & Back Arch

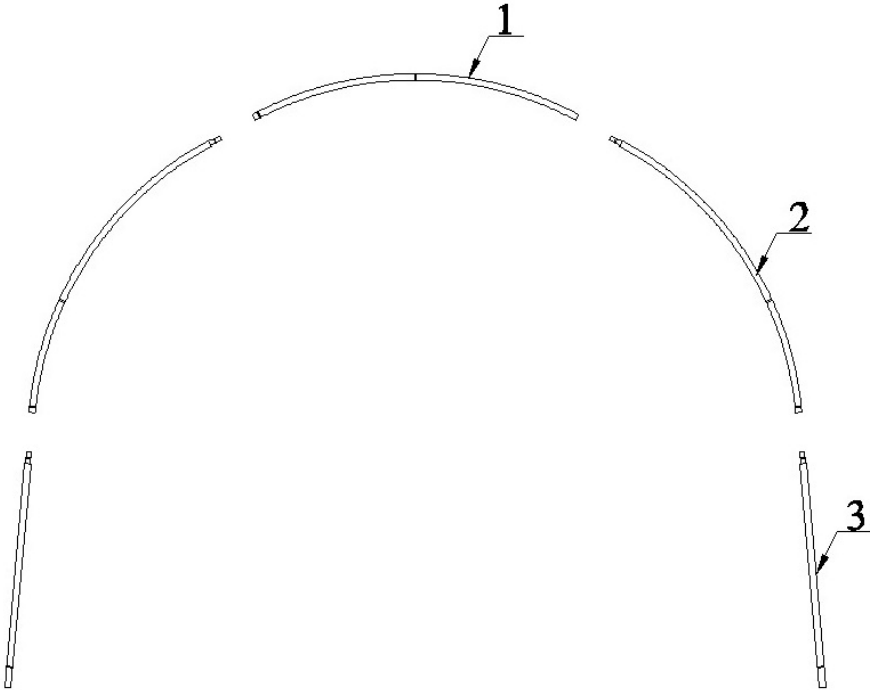

Middle Arch

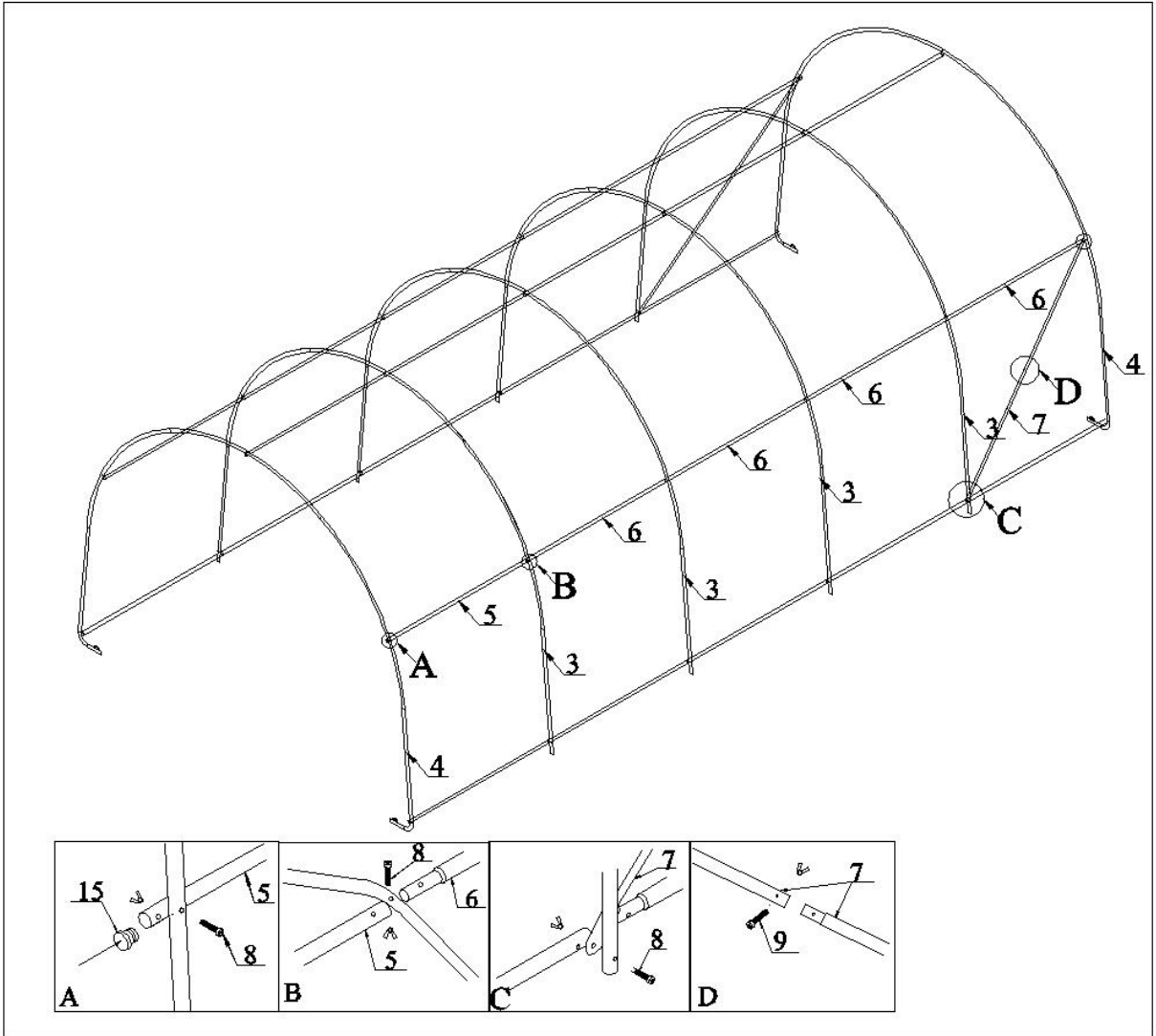

Purlin

Squaring Up The Frame and Install Stake Pegs

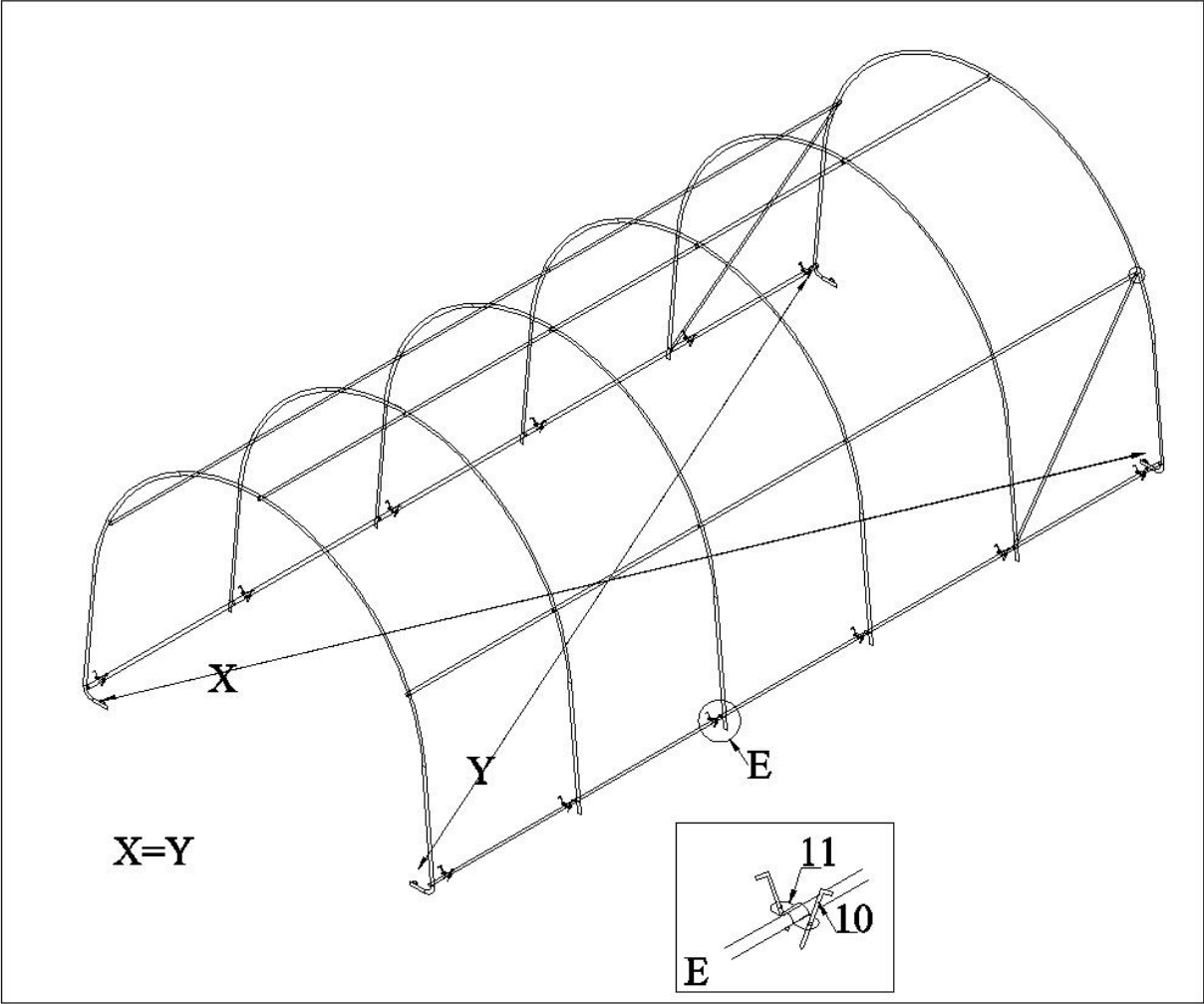

Cover Installation

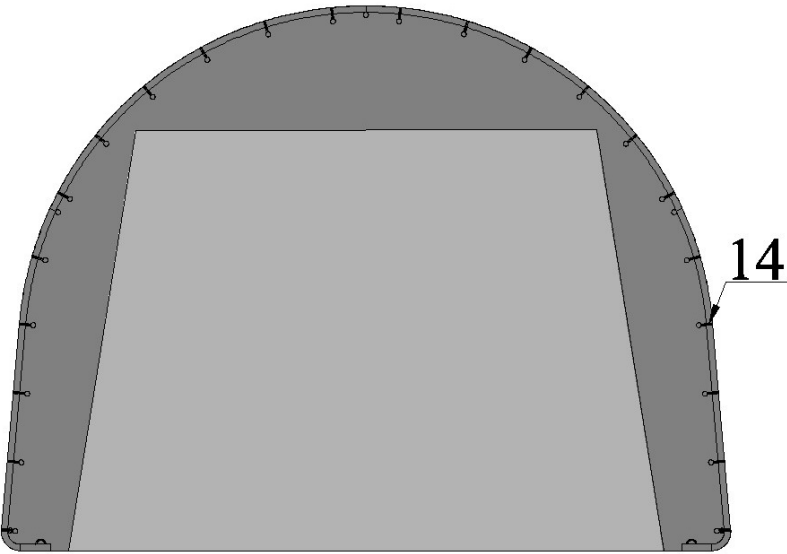

Front Cover

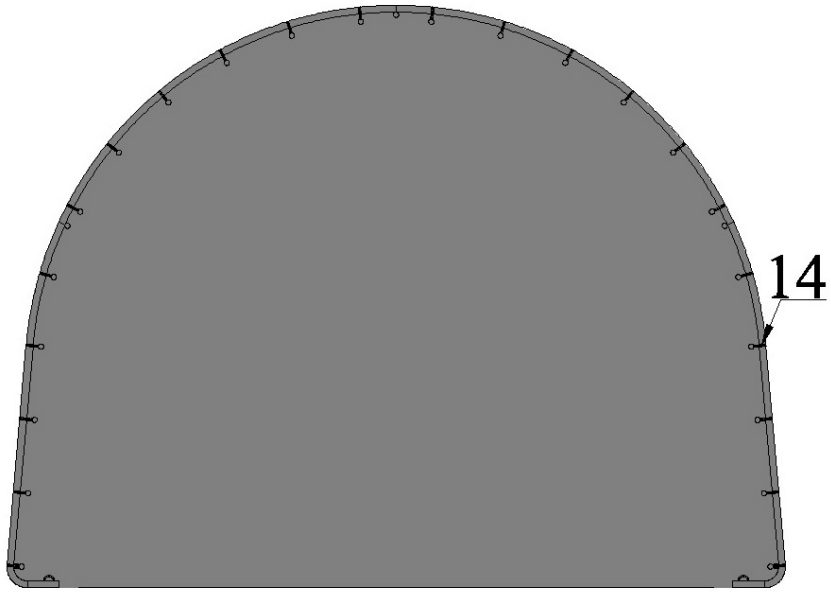

Back Cover

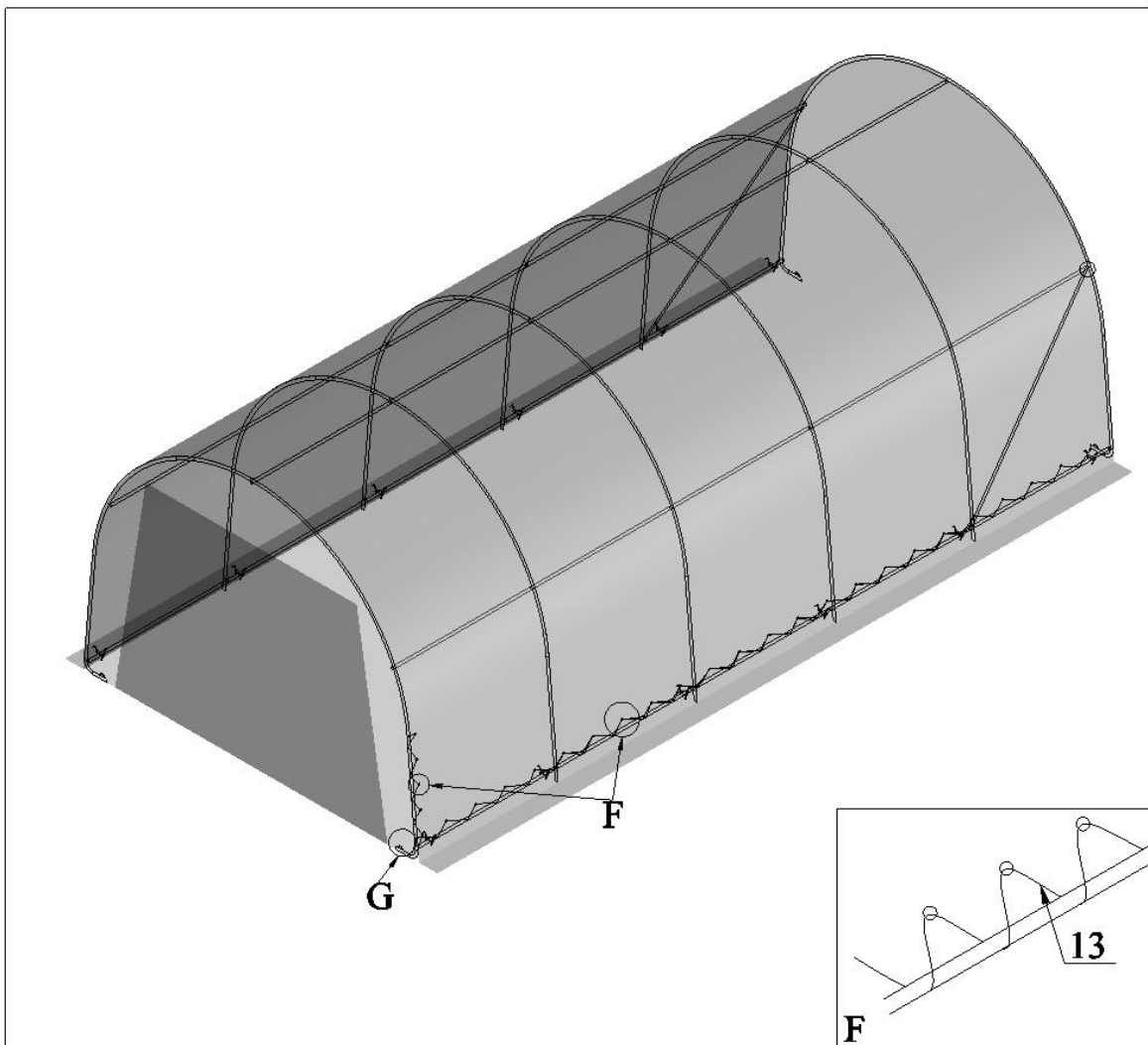

Roof Cover

1. Insert the band in the end pocket of roof cover to Winch (No.12) and the ring on Upright for front and back arches (No.4). The band goes through point a, b, c (the ring) and b again.

Note: Step 6 the winches need to be pulled as far as possible from the ring.

2. Drive the winch forth and back and then roof cover is tightened.

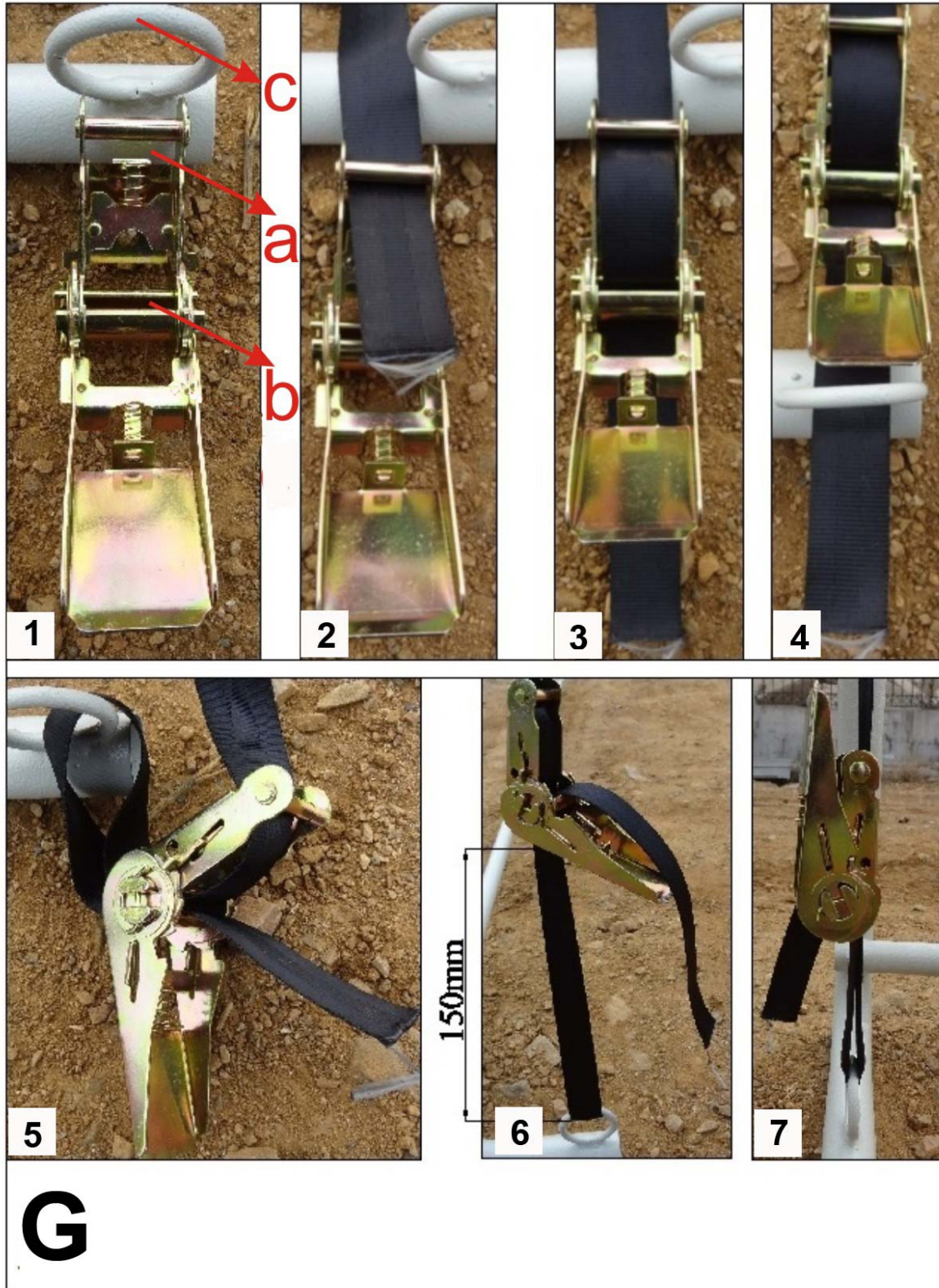

Now your assembly is completed.