

Boat Tent

SS143314 14'x33'x14'

W4.3xL10.0xH4.3m

Assembly Instructions



RECOMMENDED TOOLS



Please read instructions **COMPLETELY** before assembly. This shelter **MUST** be securely anchored
THIS IS A TEMPORARY STRUCTURE AND NOT RECOMMENDED AS A PERMANENT STRUCTURE

Before you start: 4+ individual recommended for assembly, approximate time 3 hr.

ATTENTION:

This shelter product is manufactured with quality materials. It is designed to fit our custom fabric cover included. Our shelters offer storage and protection from damage caused by sun, light rain, tree sap, animal - bird excrement and light snow. Please anchor this structure properly. See manual for more anchoring details. Proper anchoring, keeping cover tight and free of snow and debris is the responsibility of the consumer. Please read and understand the installation detail, warnings and cautions prior to beginning installation. If you have any questions contact your local dealer.

DANGER:

Prior to installation, choose the location of your shelter carefully. _

DANGER: Keep away from electrical wires.

Check for overhead utility lines, tree branches or other structures. Check for underground pipes or wires before you dig. DO NOT install near roof lines or other structures that could shed snow, ice or excessive run off onto your shelter. DO NOT hang objects from the roof or support cables.

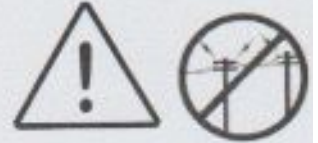

WARNING:

Risk of fire. DO NOT smoke or use open flame devices (including grills, fire pits, deep fryers, smokers or lanterns) in or around the shelter. DO NOT store flammable liquids (gasoline, kerosene, propane, etc.) in or around your shelter. Do not expose top or sides of the shelter to open fire or other flame source.



CAUTION:

Use CAUTION when erecting the frame. Use safety goggles during installation. Secure and bolt together overhead poles during assembly. Beware of pole ends.

PROPER ANCHORING AND INSTALLATION OF FRAME:

PROPER ANCHORING OF THE FRAME IS THE RESPONSIBILITY OF THE CONSUMER.

We are not responsible for damage to the unit or the contents from acts of nature. Any shelter that is not anchored securely has the potential to fly away causing damage, and is not covered under the warranty. Periodically check the anchors to ensure stability of shelter. We cannot be responsible for any shelter that blows away. _

NOTE: Your shelter's cover can be quickly removed and stored prior to severe weather conditions. If strong winds or severe weather is forecast in your area, we recommend removal of cover.

CARE AND CLEANING:

A tight cover ensures longer life and performance. Always maintain a tight cover. Loose fabric can accelerate deterioration of cover fabric. Immediately remove any accumulated snow or ice from the roof structure with a broom, mop or other soft-sided instrument. Use extreme caution when removing snow from cover- always remove from outside the structure. DO NOT use hard-edged tools or instruments like rakes or shovels to remove snow. This could result in punctures to the cover. DO NOT use bleach or harsh abrasive products to clean the fabric cover. Cover is easily cleaned with mild soap and water.













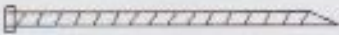

WARRANTY:

This shelter carries a full limited warranty against defects in workmanship. We warrant to the Original Purchaser that if properly used and installed, the product and all associated parts, are free from manufacturer's defects for a period of:

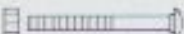
1 YEAR FOR COVER FABRIC, END PANELS AND FRAMEWORK

Boat Tent W4.3xL10.0xH4.3m Parts List

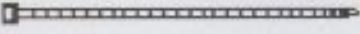
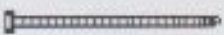
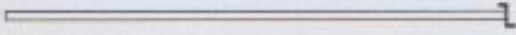
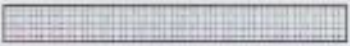
Part Code	Description of Parts	Qty(PC)
1	Roof Bent Joist	6
2	Sidewall Bent Joist for front door (left)	1
3	Sidewall Bent Joist for front door (right)	1
4	Sidewall Bent Joist for middle arches (left)	5
5	Sidewall Bent Joist for middle arches (right)	5
6	Roof Bracing Tube	6
7	Upright	8
8	Upright for Sidewall Bracing Tube (No. 10)	4
9	Purlin	25
10	Sidewall Bracing Tube	4
11	Four Corner Base Plate	4
12	Middle Base Plate	8
13	Lower Tensioning Tube	2
14	Door Bracing Tube	2

15	Deformed Bar Anchor		28
16	Roof Cover		1
17	Front Cover		1
18	Back Cover		1
19	Bolt M8x60		48
20	Bolt M8x70		24
21	Carriage Bolt M8x70		46
22	Self-drilling Screw for No. 14		4
23	Knitting Rope for Front Door		2 bundles
24	Knitting Rope for Roof Cover		1 bundle
25	Cable Tie for Roof Cover		22
26	Cable Tie for Front and Back Cover		70
27	Rod for Pulling Front Door		1
28	Webbing for Winch		12
29	Plastic Plug for lower tensioning tube No. 13		6

Frame Installation

Step 1: the first arch and roof bracing tube

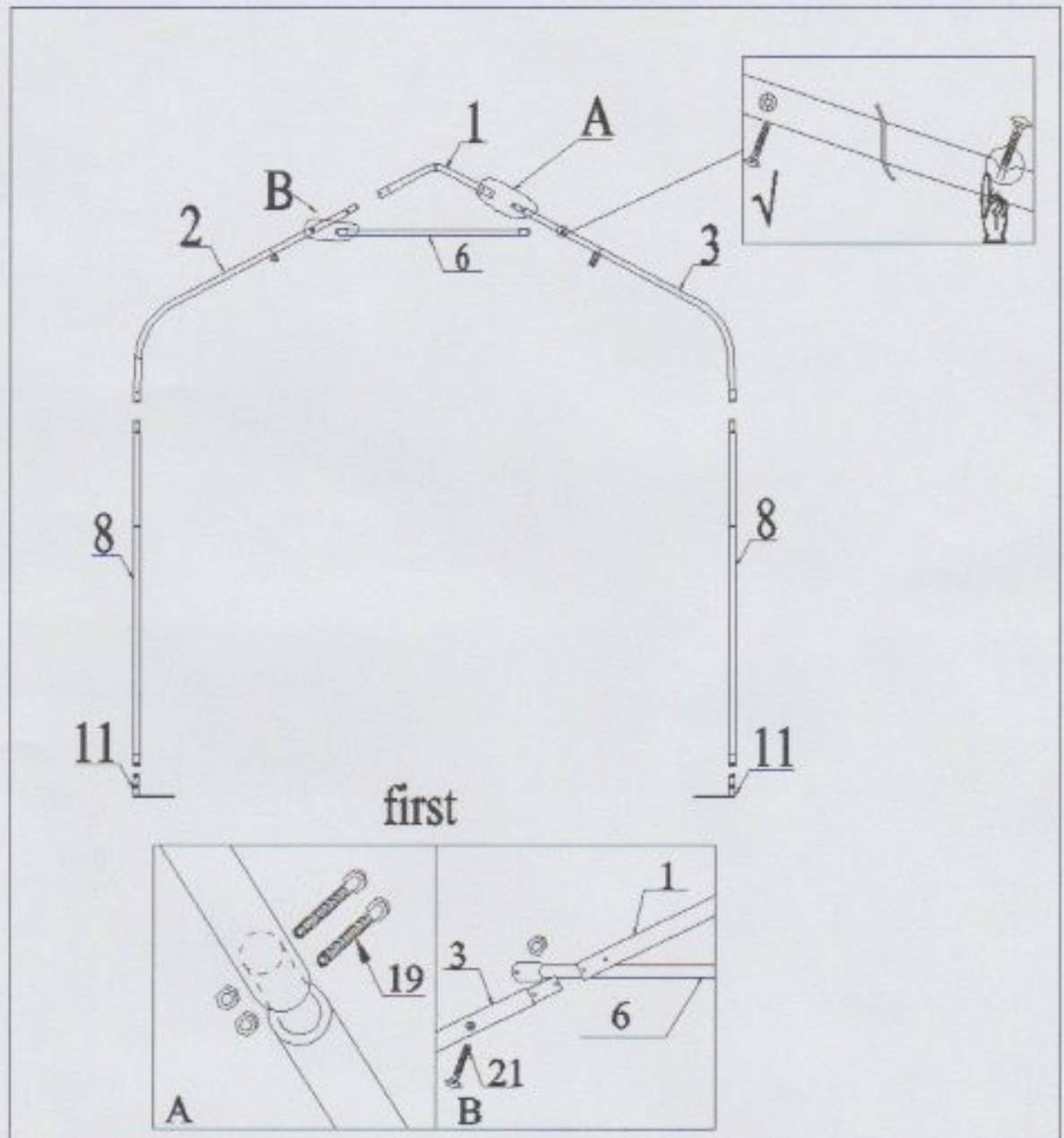

Step 2: middle arches and roof bracing tubes

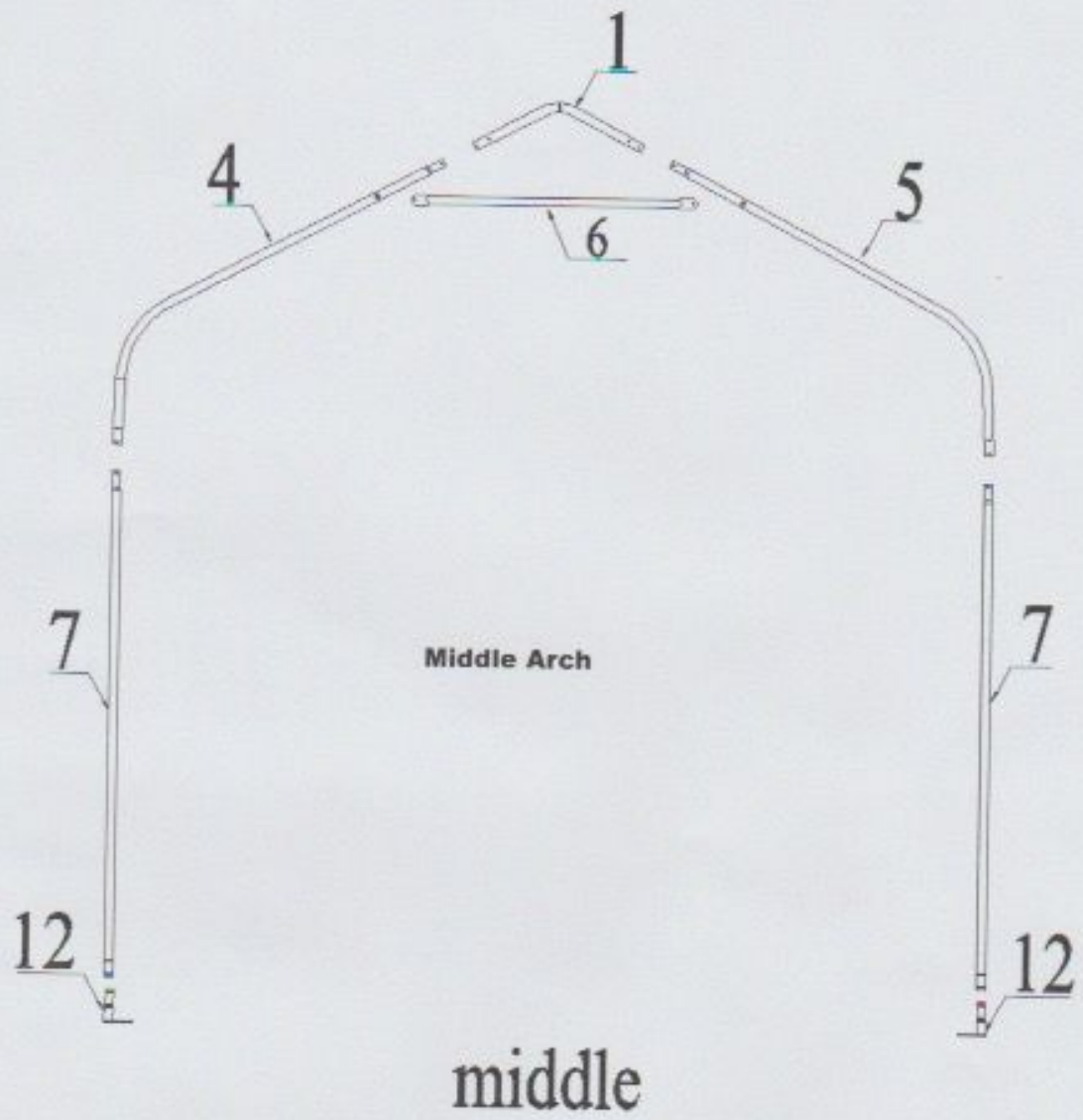

Step 3: the last arch and roof bracing tube

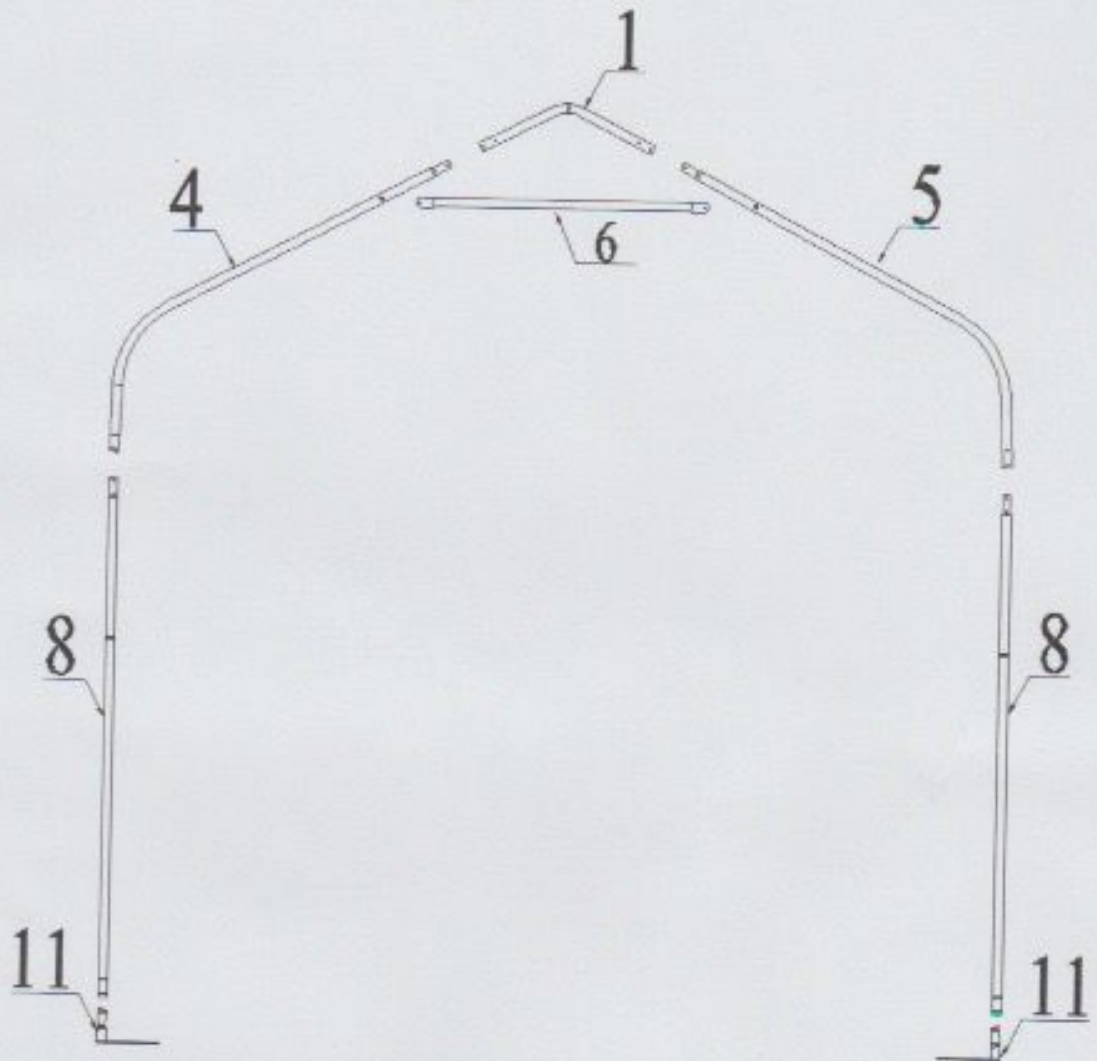

last

Step 4: purlins, sidewall bracing tubes and base plates

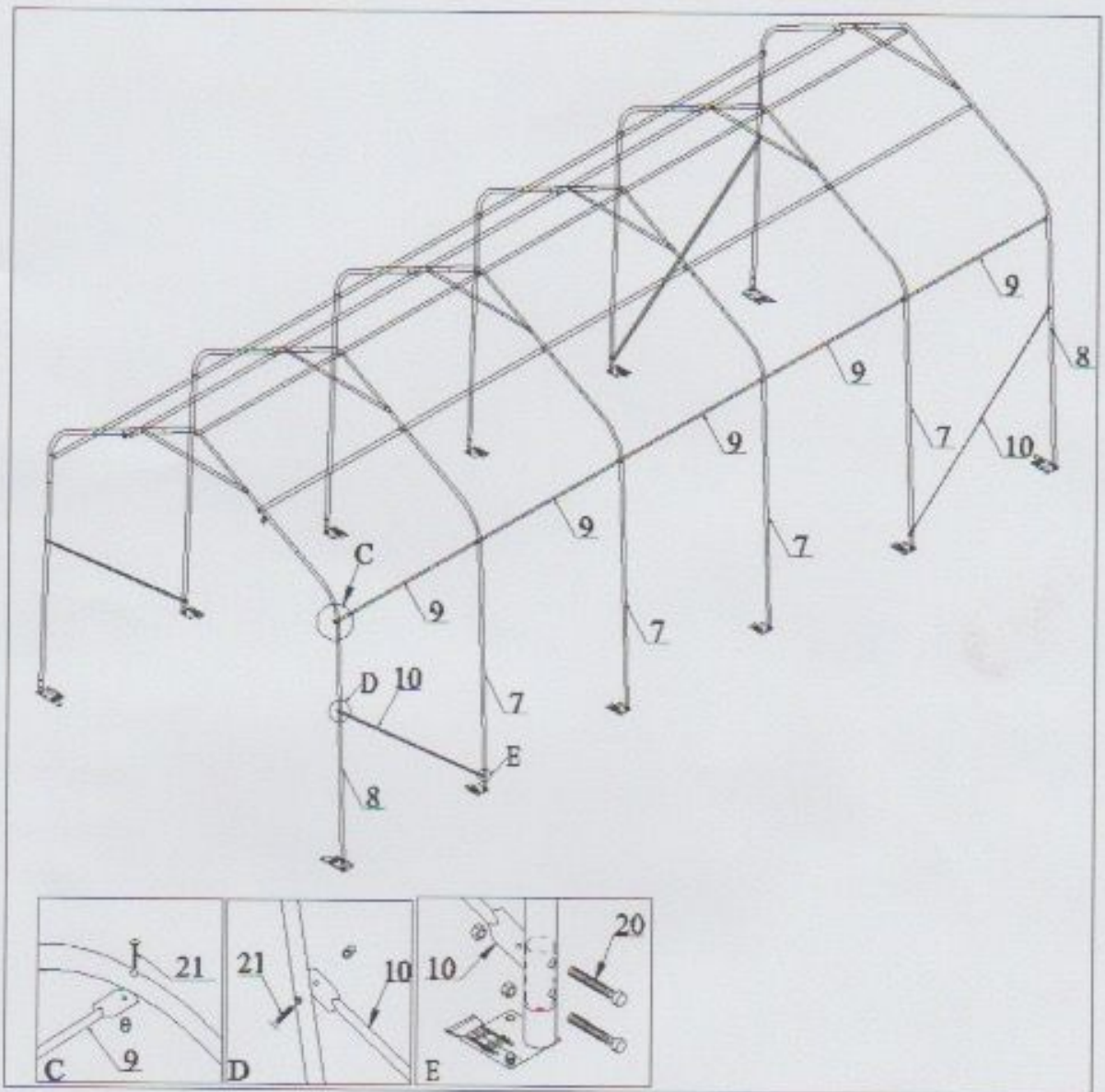

Step 5: squaring up the frame and fix base plates by anchors

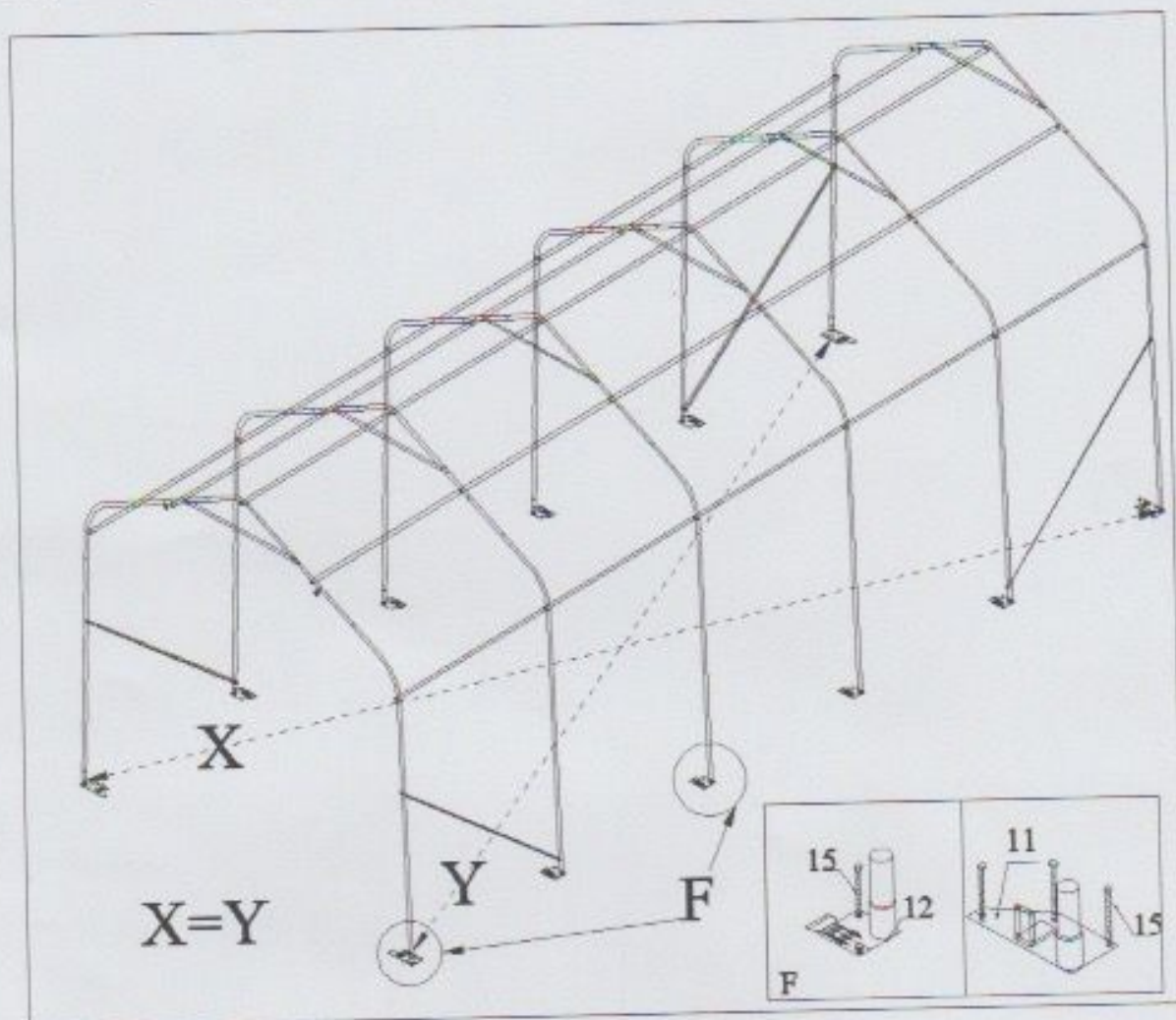

Cover Installation

Step 1: front cover with door

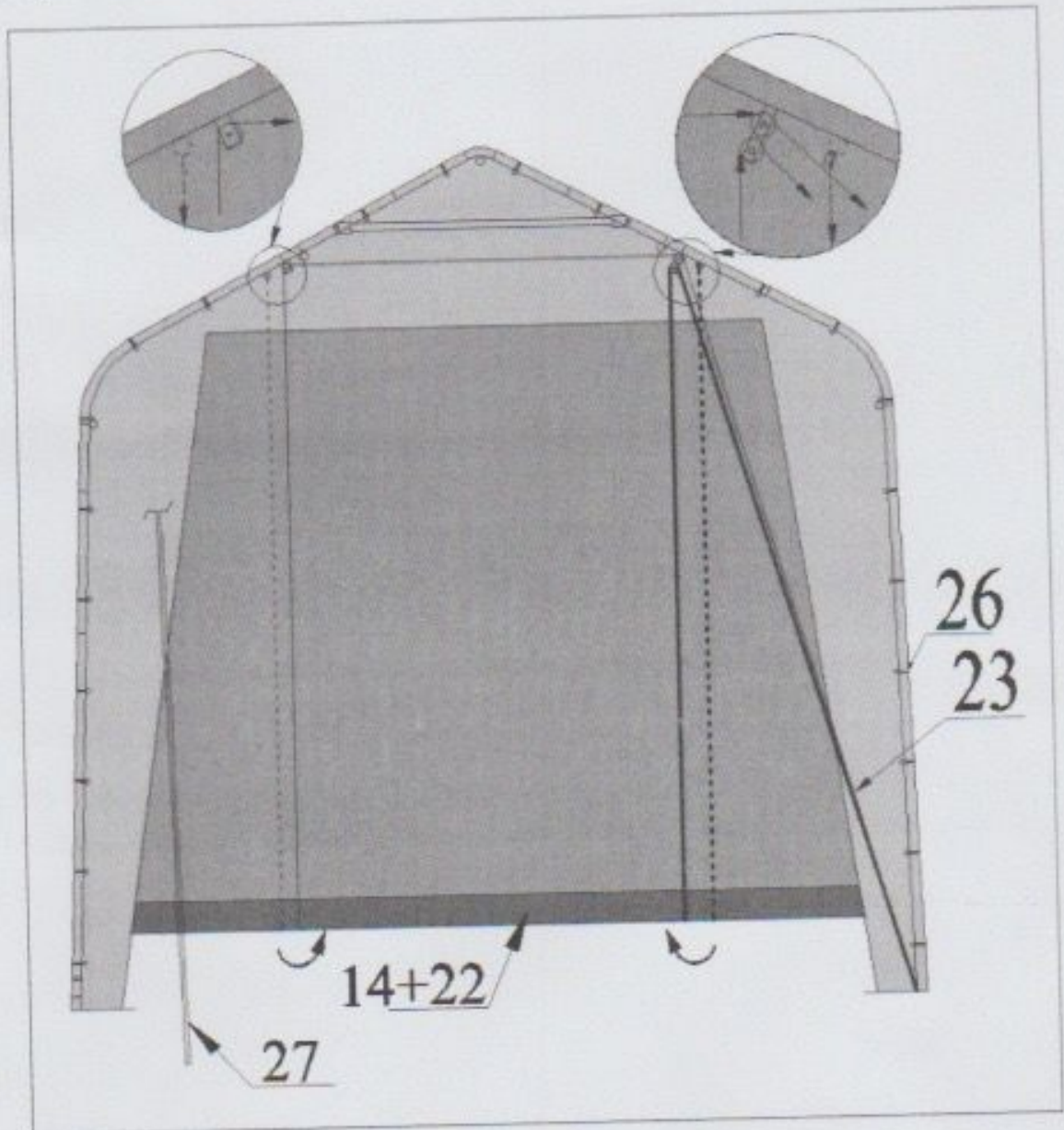

Step 2: back cover

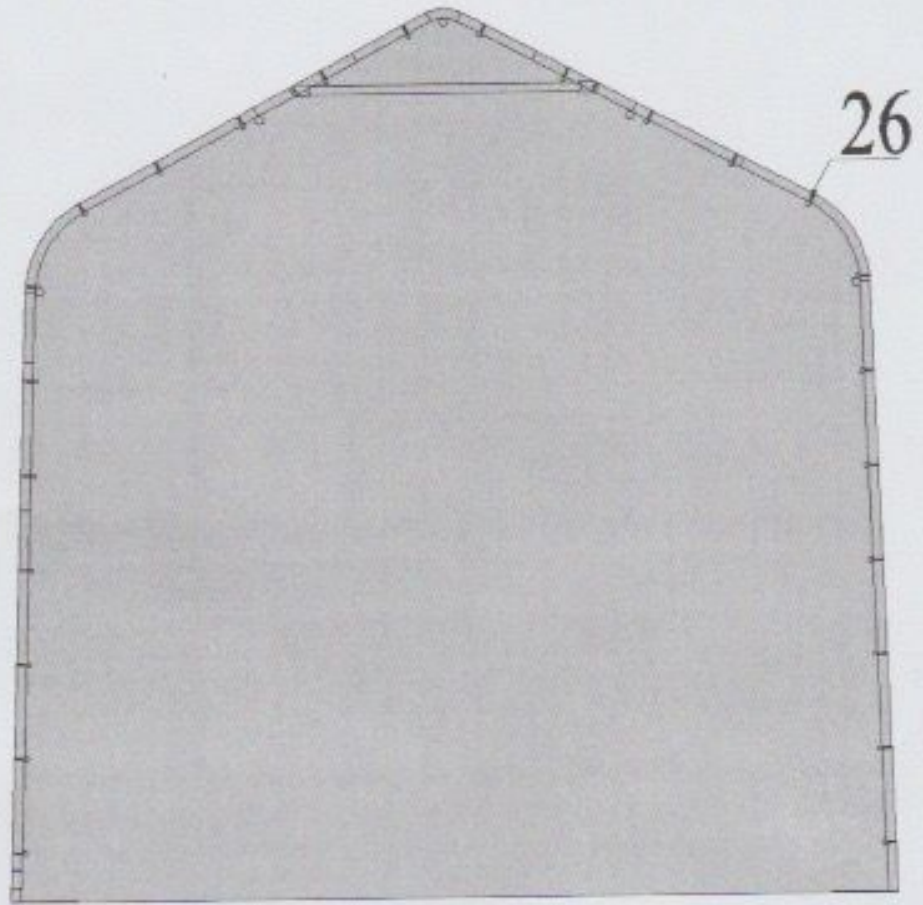

Step 3: roof cover

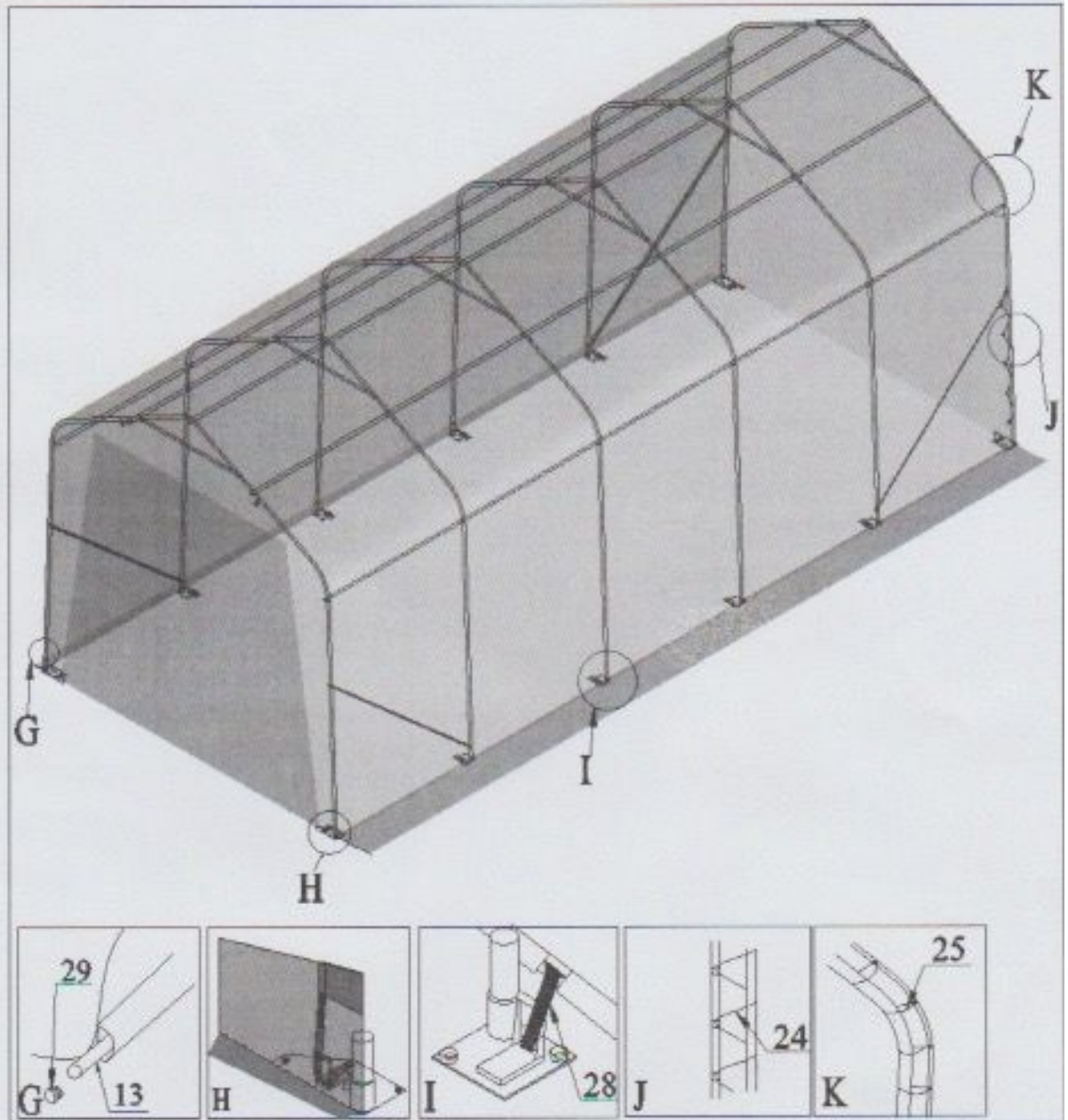

Now your assembly is completed.